

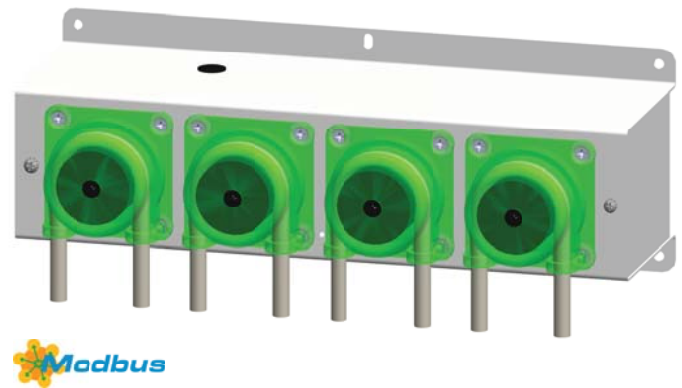









AgrowDose AD4 “quad” peristaltic dosing pump with five independent pump heads for injecting nutrient solutions, pH buffers, chlorine, chemicals, food and beverage mixing, and more. Pump precise volumes of liquids at variable flow rates into reservoirs or pressurized lines (up to 25psi) with reliable peristaltic action. Fluid stays in the pump tubing and does not contact any other parts in the pump.

AgrowDose™ pumps connect instantly to Agrowtek’s intelligent GrowControl™ cultivation controllers through the GrowNET™ port for advanced automated dosing functions, or can connect to a mini doser controller for basic dosing applications.



Pumps can draw solutions up to 100ft with a 10ft vertical lift and do not require priming. Peristaltic action resists fouling or clogging even with thick fluids. Durable pumps reliably deliver accurate doses. Economical quick change roller head can be replaced by rotating 1/8 turn and pulling off of motor shaft; replace just the tubing, or the entire head. FDA Compliant tubing and food grade lubricant.

## Features

- |   |  |
|---|--|
| <ul style="list-style-type: none"> <li> Four independent dosing pumps</li> <li> Precision dosing accuracy &lt; 1mL<br/>Variable speed, reversable</li> <li> 24V DC input power<br/>120V Wall adapter included</li> <li> Easy-change pump heads<br/>Twist &amp; replace; no tools required</li> </ul> | <ul style="list-style-type: none"> <li> GrowNET™ Digital Communication Port</li> <li> MODBUS RTU for industrial PLC control<br/>Independent variable speeds, reversable</li> <li> Durable powder-coated steel enclosure</li> <li> Made in USA</li> <li> 1-Year Warranty</li> </ul> |
|---|--|

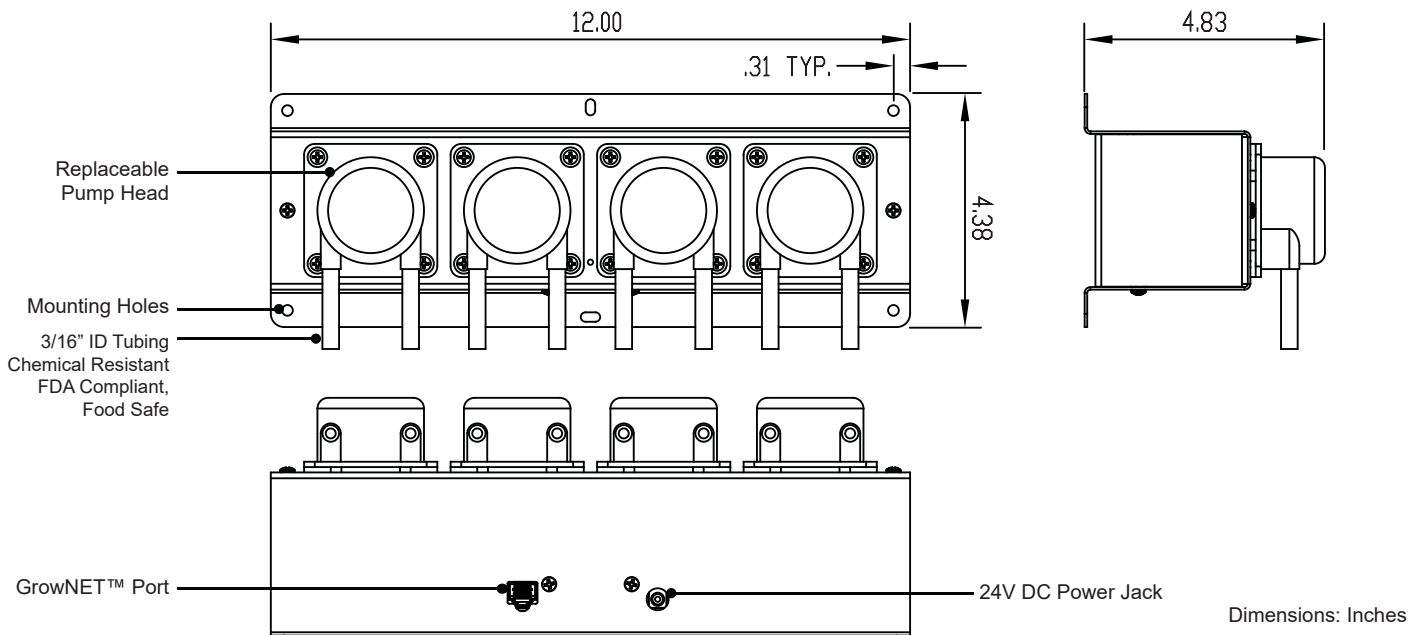

### Typical Application

ADi dosing pumps are typically installed with the outlet lines either fed into a PBX series dosing manifold in a recirculating pump line (after a sensor manifold,) or fed directly into the top of reservoir tanks.

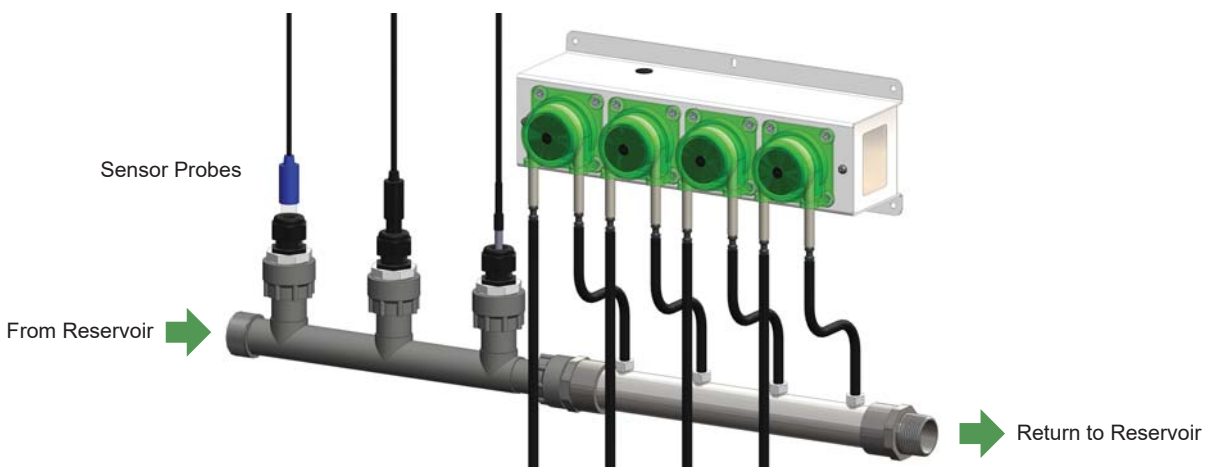

### GrowControl™ GCX Controller



Connect to GrowControl™ Cultivation Controllers for advanced functions as part of a complete facility control solution. GrowControl™ GCX systems feature intelligent control functions optimized for today's complex growing environments including dosing recipe management and scheduling.

### MINI DOSER



Combine a SXH hydro controller and AgrowDose™ ADi pump to form a powerful automatic dosing system for nutrients, pH and O.R.P. Available as a kit with pump, controller and probes, or with pre-assembled stainless steel back panel and PVC manifolds. Connect to a GCX controller for additional dosing and monitoring capability.

### MODBUS



GrowNET™ devices are easy to implement on PLC systems with MODBUS RTU and a LX2 ModLINK interface. Multiple GrowNET™ devices can be connected to an interface with HX8 GrowNET™ hubs.

### Ordering Options

**AD4i - 500**  
 500: 480mL/min max flow rate (standard)  
 Alternate speeds available special order.

### Optional Accessories

