

---

# **DDS75-LB/LS -- LoRaWAN Distance Detection Sensor User Manual**

last modified by Xiaoling

on 2025/04/21 11:55

---

# Table of Contents

1. Introduction .....	5
1.1 What is LoRaWAN Distance Detection Sensor .....	5
1.2 Features .....	6
1.3 Specification .....	6
1.4 Rated environmental conditions .....	6
1.5 Effective measurement range Reference beam pattern .....	7
1.6 Applications .....	7
1.7 Sleep mode and working mode .....	8
1.8 Button & LEDs .....	8
1.9 BLE connection .....	9
1.10 Pin Definitions .....	9
1.11 Mechanical .....	9
1.11.1 for LB version .....	9
1.11.2 for LS version .....	10
2. Configure DDS75-LB/LS to connect to LoRaWAN network .....	11
2.1 How it works .....	11
2.2 Quick guide to connect to LoRaWAN server (OTAA) .....	11
2.3 Uplink Payload .....	15
2.3.1 Device Status, FPORT=5 .....	16
2.3.2 Battery Info .....	17
2.3.3 Distance .....	17
2.3.4 Interrupt Pin .....	17
2.3.5 DS18B20 Temperature sensor .....	17
2.3.6 Sensor Flag .....	17
2.3.7 Decode payload in The Things Network .....	17
2.4 Uplink Interval .....	18
2.5 Show Data in DataCake IoT Server .....	18
2.6 Datalog Feature .....	21
2.6.1 Ways to get datalog via LoRaWAN .....	21
2.6.2 Unix TimeStamp .....	21
2.6.3 Set Device Time .....	22
2.6.4 Poll sensor value .....	22
2.7 Frequency Plans .....	22
3. Configure DDS75-LB/LS .....	23
3.1 Configure Methods .....	23
3.2 General Commands .....	23
3.3 Commands special design for DDS75-LB/LS .....	23
3.3.1 Set Transmit Interval Time .....	23
3.3.2 Set Interrupt Mode .....	23
3.3.3 Set Delta Detect Mode(Since firmware v1.3) .....	24
4. Battery & Power Consumption .....	25
5. OTA Firmware update .....	25
6. FAQ .....	25
6.1 What is the frequency plan for DDS75-LB/LS? .....	25
6.2 Can I use DDS75-LB/LS in condensation environment? .....	25
7. Trouble Shooting .....	25
7.1 Why I can't join TTN V3 in US915 / AU915 bands? .....	25
7.2 AT Command input doesn't work .....	25
7.3 Why does the sensor reading show 0 or "No sensor" .....	26
7.4 Abnormal readings The gap between multiple readings is too large or the gap between the readings and the actual value is too large .....	26
8. Order Info .....	26
9. Packing Info .....	26

10. Support ..... 27



**Table of Contents :**

- [1. Introduction](#)
  - [1.1 What is LoRaWAN Distance Detection Sensor](#)
  - [1.2 Features](#)
  - [1.3 Specification](#)
  - [1.4 Rated environmental conditions](#)
  - [1.5 Effective measurement range Reference beam pattern](#)
  - [1.6 Applications](#)
  - [1.7 Sleep mode and working mode](#)
  - [1.8 Button & LEDs](#)
  - [1.9 BLE connection](#)
  - [1.10 Pin Definitions](#)
  - [1.11 Mechanical](#)
    - [1.11.1 for LB version](#)
    - [1.11.2 for LS version](#)

- [2. Configure DDS75-LB/LS to connect to LoRaWAN network](#)
  - [2.1 How it works](#)
  - [2.2 Quick guide to connect to LoRaWAN server \(OTAA\)](#)
  - [2.3 Uplink Payload](#)
    - [2.3.1 Device Status, FPORT=5](#)
    - [2.3.2 Battery Info](#)
    - [2.3.3 Distance](#)
    - [2.3.4 Interrupt Pin](#)
    - [2.3.5 DS18B20 Temperature sensor](#)
    - [2.3.6 Sensor Flag](#)
    - [2.3.7 Decode payload in The Things Network](#)
  - [2.4 Uplink Interval](#)
  - [2.5 Show Data in DataCake IoT Server](#)
  - [2.6 Datalog Feature](#)
    - [2.6.1 Ways to get datalog via LoRaWAN](#)
    - [2.6.2 Unix TimeStamp](#)
    - [2.6.3 Set Device Time](#)
    - [2.6.4 Poll sensor value](#)
  - [2.7 Frequency Plans](#)
- [3. Configure DDS75-LB/LS](#)
  - [3.1 Configure Methods](#)
  - [3.2 General Commands](#)
  - [3.3 Commands special design for DDS75-LB/LS](#)
    - [3.3.1 Set Transmit Interval Time](#)
    - [3.3.2 Set Interrupt Mode](#)
    - [3.3.3 Set Delta Detect Mode\(Since firmware v1.3\)](#)
- [4. Battery & Power Consumption](#)
- [5. OTA Firmware update](#)
- [6. FAQ](#)
  - [6.1 What is the frequency plan for DDS75-LB/LS?](#)
  - [6.2 Can I use DDS75-LB/LS in condensation environment?](#)
- [7. Trouble Shooting](#)
  - [7.1 Why I can't join TTN V3 in US915 / AU915 bands?](#)
  - [7.2 AT Command input doesn't work](#)
  - [7.3 Why does the sensor reading show 0 or "No sensor"](#)
  - [7.4 Abnormal readings The gap between multiple readings is too large or the gap between the readings and the actual value is too large](#)
- [8. Order Info](#)
- [9. Packing Info](#)
- [10. Support](#)

# 1. Introduction

## 1.1 What is LoRaWAN Distance Detection Sensor

The Dragino DDS75-LB/LS is a **LoRaWAN Distance Detection Sensor** for Internet of Things solution. It is used to measure the distance between the sensor and a flat object. The distance detection sensor is a module that uses **ultrasonic sensing technology** for **distance measurement**, and **temperature compensation** is performed internally to improve the reliability of data. The DDS75-LB/LS can be applied to scenarios such as horizontal distance measurement, liquid level measurement, parking management system, object proximity and presence detection, intelligent trash can management system, robot obstacle avoidance, automatic control, sewer, bottom water level monitoring, etc.

It detects the distance **between the measured object and the sensor**, and uploads the value via wireless to LoRaWAN IoT Server.

The LoRa wireless technology used in DDS75-LB/LS allows device to send data and reach extremely long ranges at low data-rates. It provides ultra-long range spread spectrum communication and high interference immunity whilst minimizing current consumption.

DDS75-LB/LS **supports BLE configure** and **wireless OTA update** which make user easy to use.

DDS75-LB/LS is powered by **8500mAh Li-SOCI2 battery** or **solar powered + Li-ion battery**, it is designed for long term use up to 5 years.

Each DDS75-LB/LS is pre-load with a set of unique keys for LoRaWAN registrations, register these keys to local LoRaWAN server and it will auto connect after power on.

## 1.2 Features

- LoRaWAN 1.0.3 Class A
- Bands: CN470/EU433/KR920/US915/EU868/AS923/AU915/IN865
- Ultra-low power consumption
- Distance Detection by Ultrasonic technology
- Flat object range 280mm - 7500mm
- Accuracy:  $\pm(1\text{cm}+S*0.3\%)$  (S: Distance)
- Cable Length : 25cm
- Support Bluetooth v5.1 and LoRaWAN remote configure
- Support wireless OTA update firmware
- AT Commands to change parameters
- Downlink to change configure
- IP66 Waterproof Enclosure
- 8500mAh Li/SOCI2 Battery (DDS75-LB)
- Solar panel + 3000mAh Li-ion battery (DDS75-LS)

## 1.3 Specification

### Common DC Characteristics:

- Supply Voltage: Built-in Battery , 2.5v ~ 3.6v
- Operating Temperature: -40 ~ 85 °C

### LoRa Spec:

- Frequency Range, Band 1 (HF): 862 ~ 1020 Mhz
- Max +22 dBm constant RF output vs.
- RX sensitivity: down to -139 dBm.
- Excellent blocking immunity

### Battery:

- Li/SOCI2 un-chargeable battery
- Capacity: 8500mAh
- Self-Discharge: <1% / Year @ 25 °C
- Max continuously current: 130mA
- Max boost current: 2A, 1 second

### Power Consumption

- Sleep Mode: 5uA @ 3.3v
- LoRa Transmit Mode: 125mA @ 20dBm, 82mA @ 14dBm

## 1.4 Rated environmental conditions

Item	Minimum value	Typical value	Maximum value	Unit	Remarks
Storage temperature	-25	25	80	°C	

Storage humidity		65%	90%	RH	(1)
Operating temperature	-15	25	60	°C	
Working humidity		65%	80%	RH	(1)

**Remarks: (1) a. When the ambient temperature is 0-39 °C, the maximum humidity is 90% (non-condensing);**

**b. When the ambient temperature is 40-50 °C, the highest humidity is the highest humidity in the natural world at the current temperature (no condensation)**

## 1.5 Effective measurement range Reference beam pattern

1. The tested object is a white cylindrical tube made of PVC, with a height of 100cm and a diameter of 7.5cm.

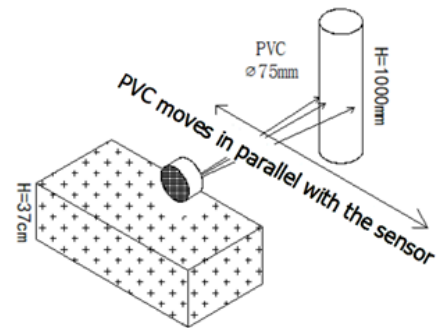
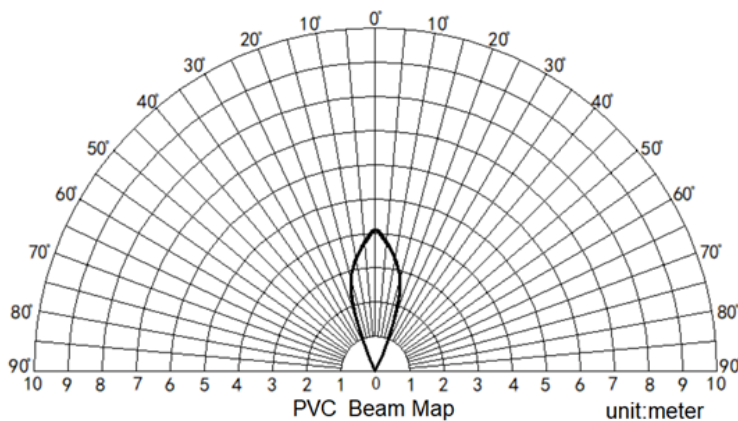

2. The object to be tested is a "corrugated cardboard box" perpendicular to the central axis of 0°, and the length \* width is 60cm \* 50cm.

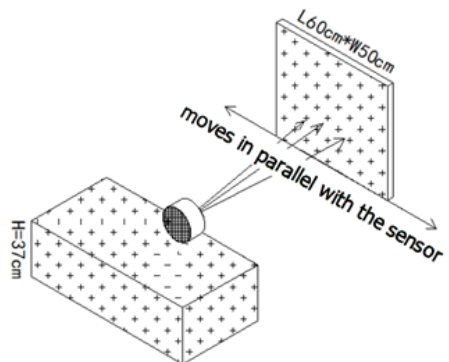
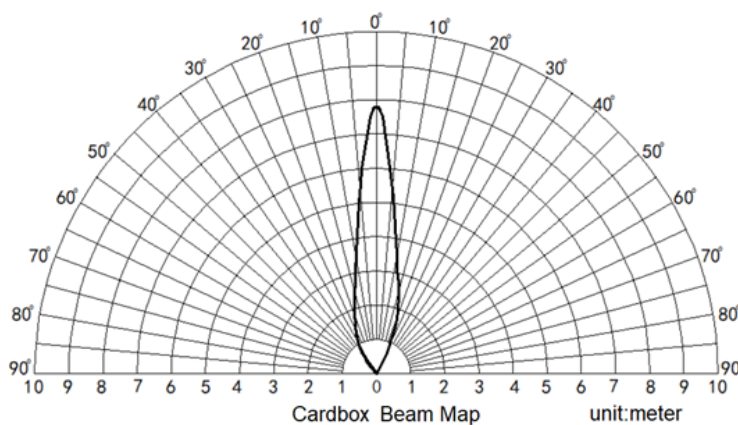

## 1.6 Applications

- Horizontal distance measurement

- Liquid level measurement
- Parking management system
- Object proximity and presence detection
- Intelligent trash can management system
- Robot obstacle avoidance
- Automatic control
- Sewer
- Bottom water level monitoring

## 1.7 Sleep mode and working mode

**Deep Sleep Mode:** Sensor doesn't have any LoRaWAN activate. This mode is used for storage and shipping to save battery life.

**Working Mode:** In this mode, Sensor will work as LoRaWAN Sensor to Join LoRaWAN network and send out sensor data to server. Between each sampling/tx/rx periodically, sensor will be in IDLE mode), in IDLE mode, sensor has the same power consumption as Deep Sleep mode.

## 1.8 Button & LEDs

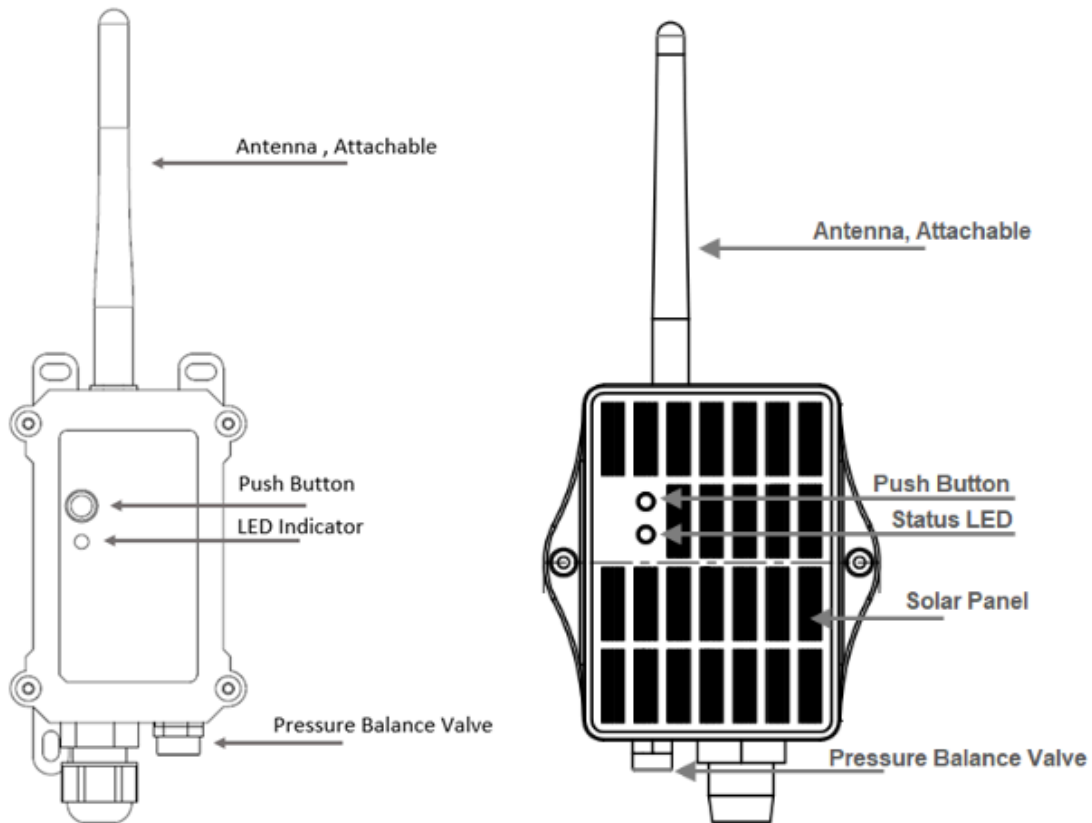

Behavior on ACT	Function	Action
Pressing ACT between 1s < time < 3s	Send an uplink	If sensor is already Joined to LoRaWAN network, sensor will send an uplink packet, <b>blue led</b> will blink once. Meanwhile, BLE module will be active and user can connect via BLE to configure device.
Pressing ACT for more than 3s	Active Device	<b>Green led</b> will fast blink 5 times, device will enter <b>OTA mode</b> for 3 seconds. And then start to JOIN LoRaWAN network.

Fast press ACT 5 times.

Deactivate Device

**Green led** will solidly turn on for 5 seconds after joined in network.

Once sensor is active, BLE module will be active and user can connect via BLE to configure device, no matter if device join or not join LoRaWAN network.

**Red led** will solid on for 5 seconds. Means device is in Deep Sleep Mode.

## 1.9 BLE connection

DDS75-LB/LS support BLE remote configure.

BLE can be used to configure the parameter of sensor or see the console output from sensor. BLE will be only activate on below case:

- Press button to send an uplink
- Press button to active device.
- Device Power on or reset.

If there is no activity connection on BLE in 60 seconds, sensor will shut down BLE module to enter low power mode.

## 1.10 Pin Definitions

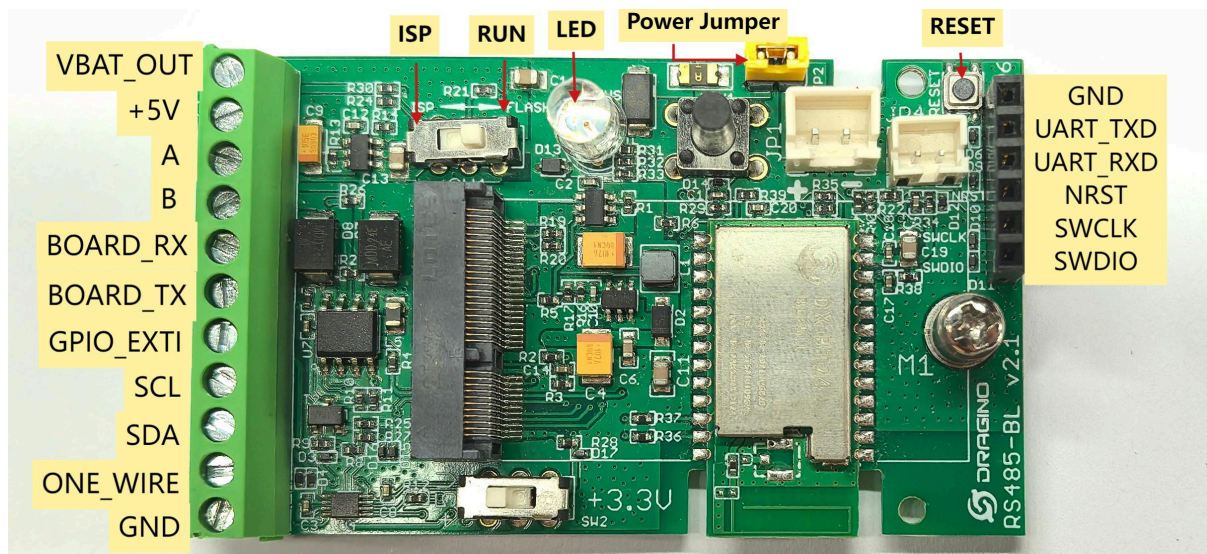

## 1.11 Mechanical

### 1.11.1 for LB version

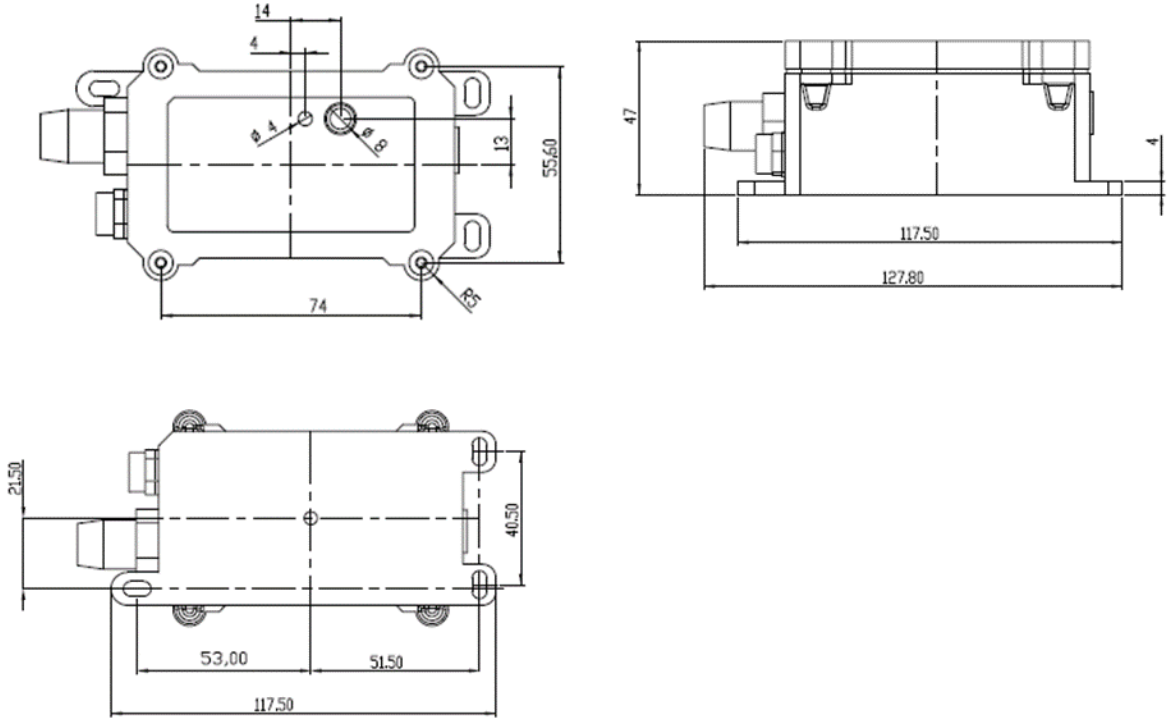

**Probe Mechanical:**

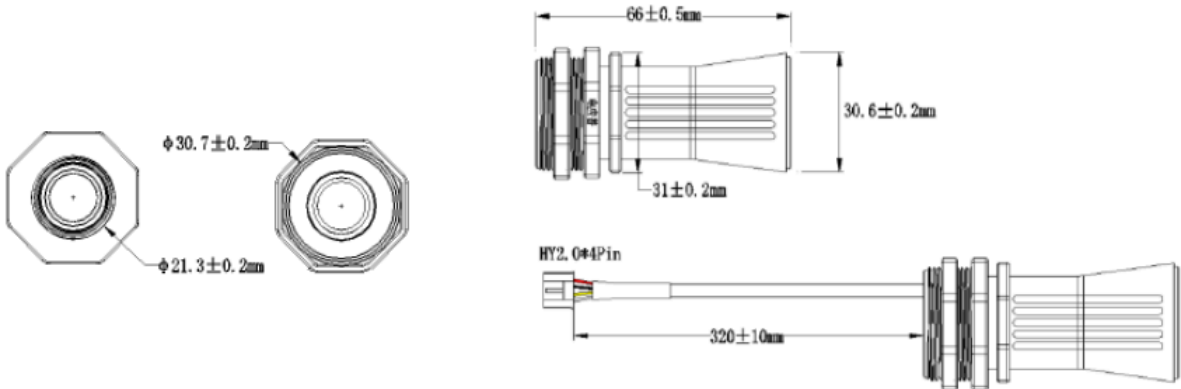

**1.11.2 for LS version**

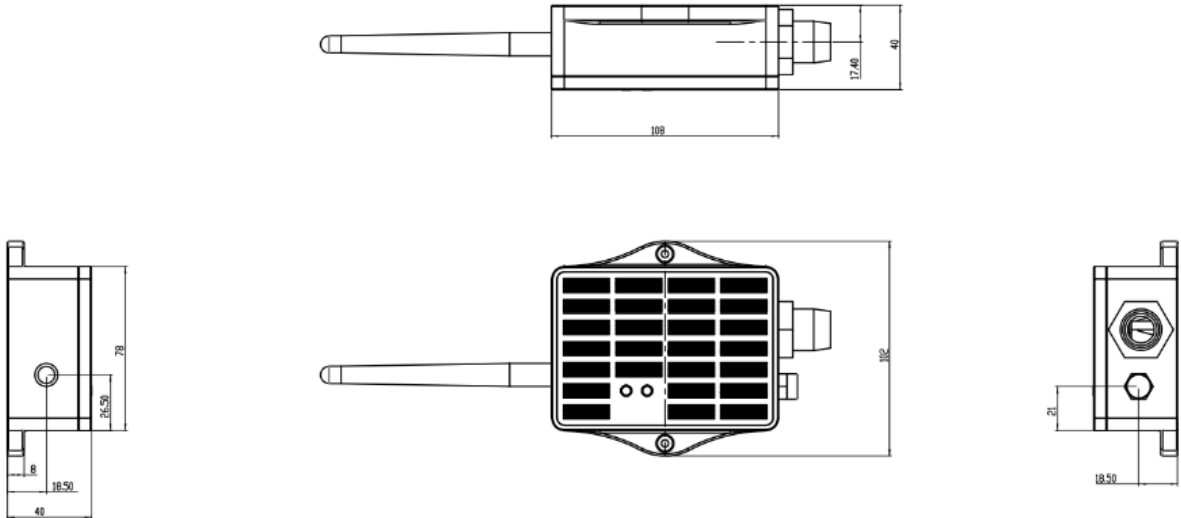

## 2. Configure DDS75-LB/LS to connect to LoRaWAN network

### 2.1 How it works

The DDS75-LB/LS is configured as **LoRaWAN OTAA Class A** mode by default. It has OTAA keys to join LoRaWAN network. To connect a local LoRaWAN network, you need to input the OTAA keys in the LoRaWAN IoT server and press the button to activate the DDS75-LB/LS. It will automatically join the network via OTAA and start to send the sensor value. The default uplink interval is 20 minutes.

### 2.2 Quick guide to connect to LoRaWAN server (OTAA)

Following is an example for how to join the [TTN v3 LoRaWAN Network](#). Below is the network structure; we use the [LPS8v2](#) as a LoRaWAN gateway in this example.

The LPS8v2 is already set to connected to [TTN network](#), so what we need to now is configure the TTN server.

### DDS75-LB in a LoRaWAN Network



**Step 1:** Create a device in TTN with the OTAA keys from DDS75-LB/LS.

Each DDS75-LB/LS is shipped with a sticker with the default device EUI as below:

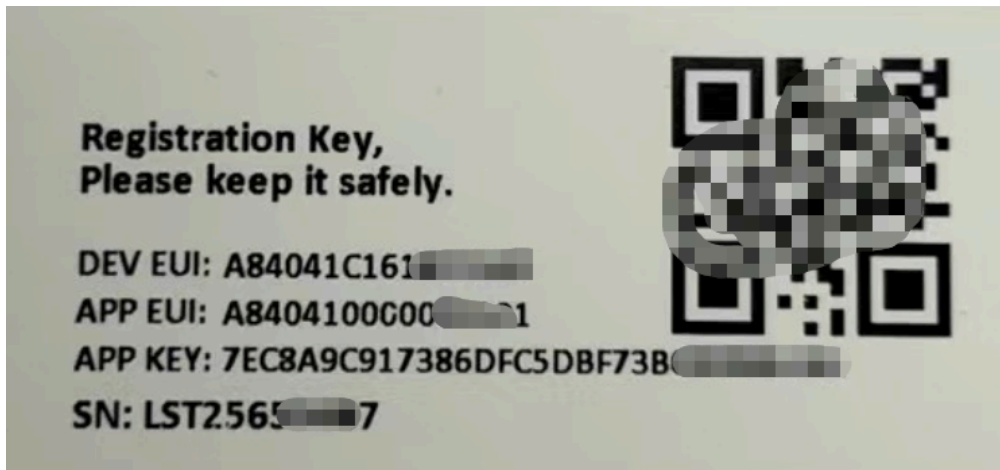

You can enter this key in the LoRaWAN Server portal. Below is TTN screen shot:

### Register the device

#### Register end device

From The LoRaWAN Device Repository Manually

##### Preparation

Activation mode\*

- Over the air activation (OTAA)
- Activation by personalization (ABP)
- Multicast
- Do not configure activation

LoRaWAN version ⓘ\*

MAC V1.0.3



Network Server address

eu1.cloud.thethings.network

Application Server address

eu1.cloud.thethings.network

External Join Server ⓘ

Enabled

Join Server address

eu1.cloud.thethings.network

Start



### Add APP EUI and DEV EUI

## Register end device

From The LoRaWAN Device Repository [Manually](#)

- 1 Basic settings**  
End device ID's, Name and Description
- 2 Network layer settings**  
Frequency plan, regional parameters, end device class and session keys.
- 3 Join settings**  
Root keys, NetID and kek labels.

End device ID  \*

lsnpk01

AppEUI  \*

.. . . . . 00

DevEUI  \*

.. . . . .

End device name

LSNPK01

End device description

Description for my new end device

Optional end device description; can also be used to save notes about the end device

[Network layer settings >](#)

### Add APP EUI in the application

## Register end device

From The LoRaWAN Device Repository [Manually](#)

- 1 **Basic settings**  
End device ID's, Name and Description
- 2 **Network layer settings**  
Frequency plan, regional parameters, end device class and session keys.
- 3 **Join settings**  
Root keys, NetID and kek labels.

**Frequency plan** ⓘ \*

Europe 863-870 MHz (SF12 for RX2) ▼

**LoRaWAN version** ⓘ \*

MAC V1.0.3 ▼

**Regional Parameters version** ⓘ \*

PHY V1.0.3 REV A ▼

**LoRaWAN class capabilities** ⓘ

Supports class B

Supports class C

**Advanced settings** ▼

< Basic settings Join settings >

### Add APP KEY

## Register end device

From The LoRaWAN Device Repository **Manually**

1 **Basic settings**  
End device ID's, Name and Description

2 **Network layer settings**  
Frequency plan, regional parameters, end device class and session keys.

3 **Join settings**  
Root keys, NetID and kek labels.

**Root keys**

AppKey

Advanced settings ▾

[← Network layer settings](#) [Add end device](#)

### Step 2: Activate on DDS75-LB/LS

Press the button for 5 seconds to activate the DDS75-LB/LS.

**Green led** will fast blink 5 times, device will enter **OTA mode** for 3 seconds. And then start to JOIN LoRaWAN network. **Green led** will solidly turn on for 5 seconds after joined in network.

After join success, it will start to upload messages to TTN and you can see the messages in the panel.

## 2.3 Uplink Payload

DDS75-LB/LS will uplink payload via LoRaWAN with below payload format:

Uplink payload includes in total 8 bytes.

Size(bytes)	2	2	1	2	1
Value	<a href="#">BAT</a>	<a href="#">Distance (unit: mm)</a>	<a href="#">Digital Interrupt (Optional)</a>	<a href="#">Temperature (Optional)</a>	<a href="#">Sensor Flag</a>

```

13:59:52 Schedule data downlink for transmissi... DevAddr: 26 08 C9 6F Rx1 Delay: 5
13:59:52 Forward uplink data message DevAddr: 26 08 C9 6F Payload: { Bat: 3.283, Distance: 2961, Interrupt_flag: 0, Sensor_flag: 1, TempC_DS18B20: "327.66" } 0C 03 8B 91 00 0C CC 01 FPort: 2 Data
13:59:52 Successfully processed data message DevAddr: 26 08 C9 6F
13:57:52 Schedule data downlink for transmissi... DevAddr: 26 08 C9 6F Rx1 Delay: 5
13:57:52 Forward uplink data message DevAddr: 26 08 C9 6F Payload: { Bat: 3.283, Distance: 2907, Interrupt_flag: 0, Sensor_flag: 1, TempC_DS18B20: "327.66" } 0C 03 8B AB 00 0C CC 01 FPort: 2 Data
    
```

### 2.3.1 Device Status, FPORT=5

Users can use the downlink command(0x26 01) to ask DDS75-LB/LS to send device configure detail, include device configure status. DDS75-LB/LS will uplink a payload via FPort=5 to server.

The Payload format is as below.

Device Status (FPORT=5)					
Size(bytes)	1	2	1	1	2
Value	Sensor Model	Firmware Version	Frequency Band	Sub-band	BAT



**Sensor Model:** For DDS75-LB/LS, this value is 0x27

**Firmware Version:** 0x0100, Means: v1.0.0 version

**Frequency Band:**

- 0x01: EU868
- 0x02: US915
- 0x03: IN865
- 0x04: AU915
- 0x05: KZ865
- 0x06: RU864
- 0x07: AS923
- 0x08: AS923-1
- 0x09: AS923-2
- 0x0a: AS923-3
- 0x0b: CN470
- 0x0c: EU433
- 0x0d: KR920
- 0x0e: MA869

**Sub-Band:**

- AU915 and US915: value 0x00 ~ 0x08
- CN470: value 0x0B ~ 0x0C
- Other Bands: Always 0x00

**Battery Info:**

Check the battery voltage.

Ex1: 0x0B45 = 2885mV

Ex2: 0x0B49 = 2889mV

### 2.3.2 Battery Info

Check the battery voltage for DDS75-LB/LS.

Ex1: 0x0B45 = 2885mV

Ex2: 0x0B49 = 2889mV

### 2.3.3 Distance

Get the distance. Flat object range 280mm - 7500mm.

For example, if the data you get from the register is 0x0B 0x05, the distance between the sensor and the measured object is

**0B05(H) = 2821 (D) = 2821 mm.**

- If the sensor value is 0x0000, it means system doesn't detect ultrasonic sensor.
- If the sensor value lower than 0x0118 (280mm), the sensor value will be invalid. All value lower than 280mm will be set to 0x0014(20mm) which means the value is invalid.

### 2.3.4 Interrupt Pin

This data field shows if this packet is generated by interrupt or not. [Click here](#) for the hardware and software set up.

**Example:**

0x00: Normal uplink packet.

0x01: Interrupt Uplink Packet.

### 2.3.5 DS18B20 Temperature sensor

This is optional, user can connect external DS18B20 sensor to the +3.3v, 1-wire and GND pin . and this field will report temperature.

**Example:**

If payload is: 0105H: (0105 & FC00 == 0), temp = 0105H /10 = 26.1 degree

If payload is: FF3FH : (FF3F & FC00 == 1) , temp = (FF3FH - 65536)/10 = -19.3 degrees.

### 2.3.6 Sensor Flag

0x01: Detect Ultrasonic Sensor

0x00: No Ultrasonic Sensor

### 2.3.7 Decode payload in The Things Network

While using TTN network, you can add the payload format to decode the payload.

The payload decoder function for TTN V3 is here:

DDS75-LB/LS TTN V3 Payload Decoder: <https://github.com/dragino/dragino-end-node-decoder>

## 2.4 Uplink Interval

The DDS75-LB/LS by default uplink the sensor data every 20 minutes. User can change this interval by AT Command or LoRaWAN Downlink Command. See this link: [Change Uplink Interval](#)

## 2.5 Show Data in DataCake IoT Server

[DATA CAKE](#) provides a human friendly interface to show the sensor data, once we have data in TTN, we can use [DATA CAKE](#) to connect to TTN and see the data in DATA CAKE. Below are the steps:

**Step 1:** Be sure that your device is programmed and properly connected to the network at this time.

**Step 2:** To configure the Application to forward data to DATA CAKE you will need to add integration. To add the DATA CAKE integration, perform the following steps:

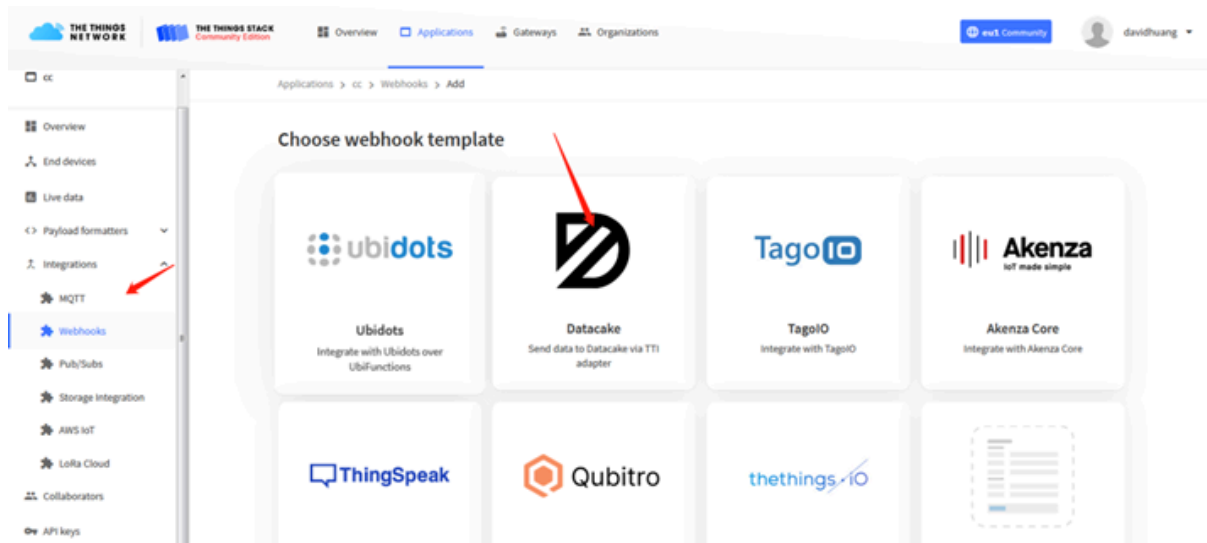

Applications > lgt92test > Webhooks > Add > Datacake

## Add custom webhook

### Template information



#### Datacake

Send data to Datacake via TTI adapter

[About Datacake](#) | [Documentation](#)

### Template settings

Webhook ID\*

Token\*

Datacake API Token

Create datacake webhook

**Step 3:** Create an account or log in Datacake.

**Step 4:** Search the DDS75-LB/LS and add DevEUI.

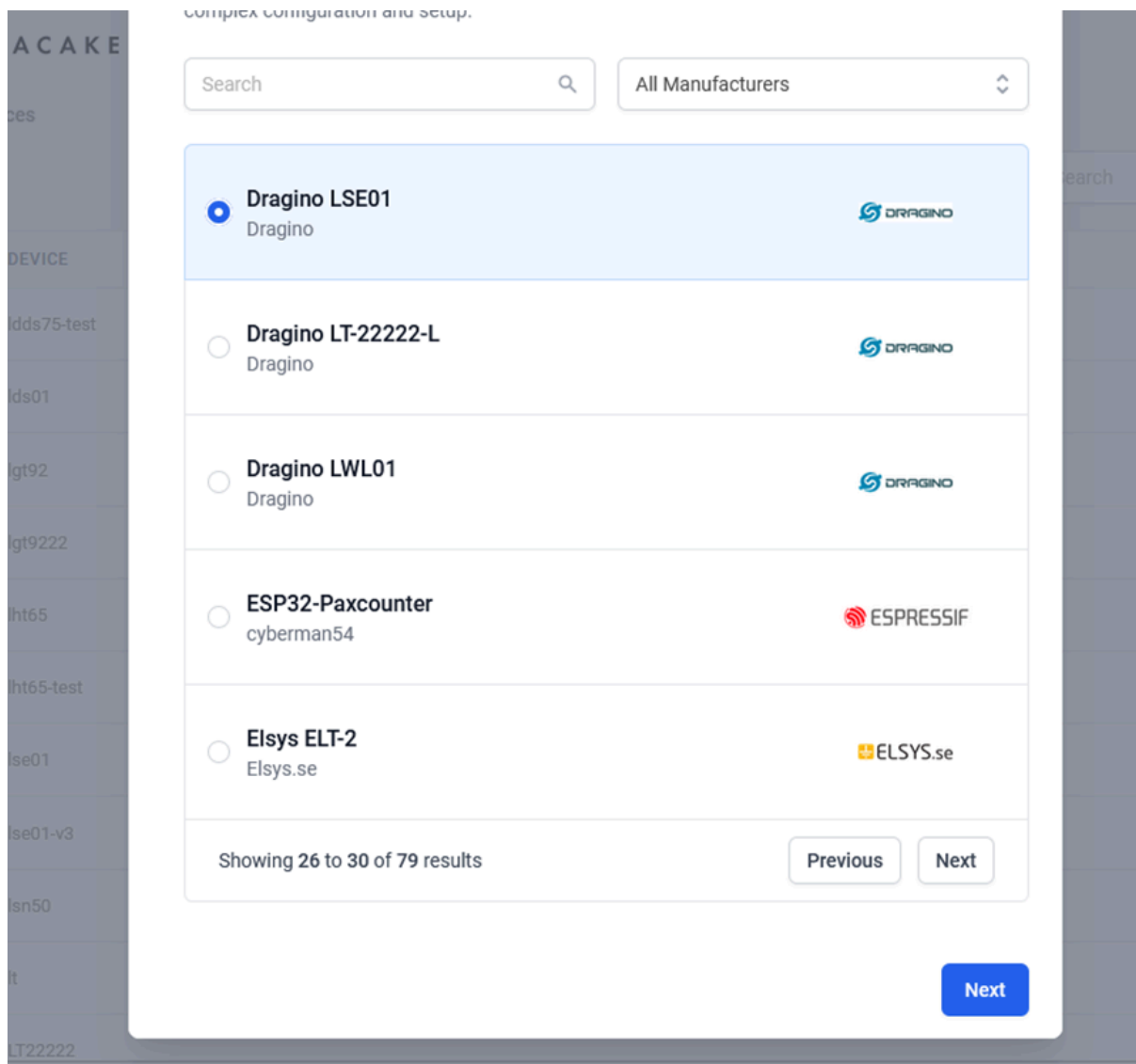

After added, the sensor data arrive TTN V3, it will also arrive and show in Datacake.

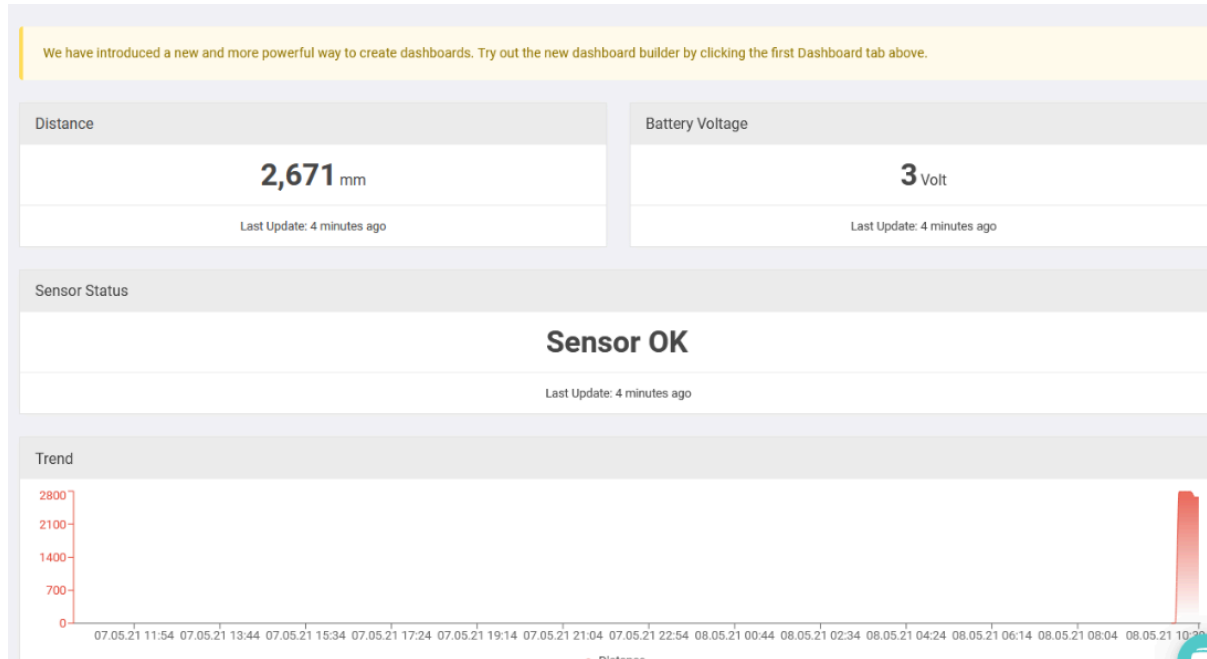

## 2.6 Datalog Feature

Datalog Feature is to ensure IoT Server can get all sampling data from Sensor even if the LoRaWAN network is down. For each sampling, DDS75-LB/LS will store the reading for future retrieving purposes.

### 2.6.1 Ways to get datalog via LoRaWAN

Set PNACKMD=1, DDS75-LB/LS will wait for ACK for every uplink, when there is no LoRaWAN network, DDS75-LB/LS will mark these records with non-ack messages and store the sensor data, and it will send all messages (10s interval) after the network recovery.

- a) DDS75-LB/LS will do an ACK check for data records sending to make sure every data arrive server.
- b) DDS75-LB/LS will send data in **CONFIRMED Mode** when PNACKMD=1, but DDS75-LB/LS won't re-transmit the packet if it doesn't get ACK, it will just mark it as a NONE-ACK message. In a future uplink if DDS75-LB/LS gets a ACK, DDS75-LB/LS will consider there is a network connection and resend all NONE-ACK messages.

### 2.6.2 Unix TimeStamp

DDS75-LB/LS uses Unix TimeStamp format based on

Size (bytes)	4	1
DeviceTimeAns Payload	32-bit unsigned integer : Seconds since epoch*	8bits unsigned integer: fractional-second in $\frac{1}{2}^8$ second steps

Figure 10 : DeviceTimeAns payload format

User can get this time from link: <https://www.epochconverter.com/> :

Below is the converter example

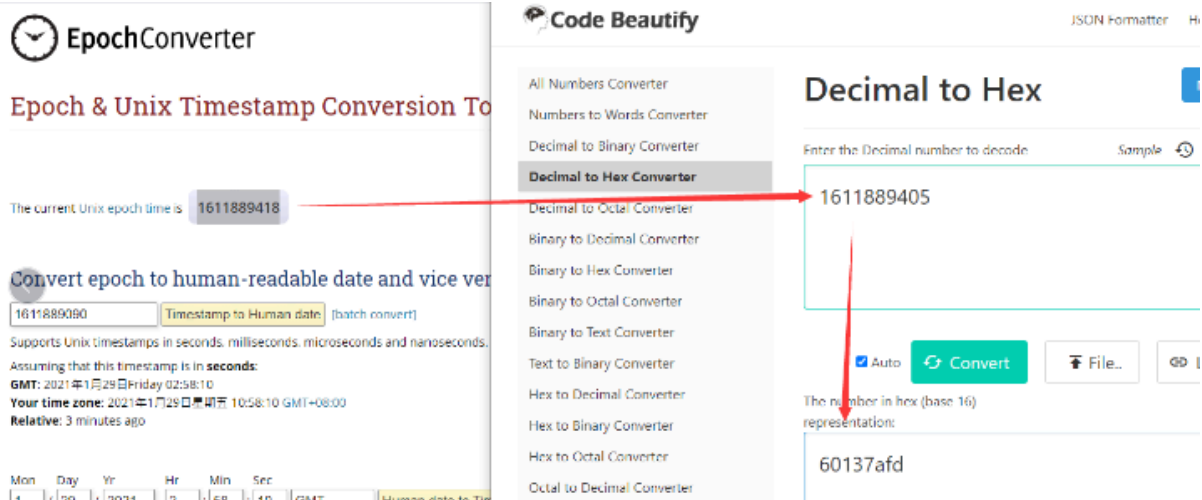

So, we can use AT+TIMESTAMP=1611889405 or downlink 3060137afd00 to set the current time 2021 – Jan -- 29 Friday 03:03:25

### 2.6.3 Set Device Time

User need to set **SYNCMOD=1** to enable sync time via MAC command.

Once DDS75-LB/LS Joined LoRaWAN network, it will send the MAC command (DeviceTimeReq) and the server will reply with (DeviceTimeAns) to send the current time to DDS75-LB/LS. If DDS75-LB/LS fails to get the time from the server, DDS75-LB/LS will use the internal time and wait for next time request (AT+SYNCTDC to set the time request period, default is 10 days).

**Note: LoRaWAN Server need to support LoRaWAN v1.0.3(MAC v1.0.3) or higher to support this MAC command feature, Chirpstack,TTN V3 v3 and loriot support but TTN V3 v2 doesn't support. If server doesn't support this command, it will through away uplink packet with this command, so user will lose the packet with time request for TTN V3 v2 if SYNCMOD=1.**

### 2.6.4 Poll sensor value

Users can poll sensor values based on timestamps. Below is the downlink command.

Downlink Command to poll Open/Close status (0x31)			
<b>1byte</b>	<b>4bytes</b>	<b>4bytes</b>	<b>1byte</b>
31	Timestamp start	Timestamp end	Uplink Interval

Timestamp start and Timestamp end-use Unix TimeStamp format as mentioned above. Devices will reply with all data logs during this period, using the uplink interval.

For example, downlink command

Is to check 2021/11/12 12:00:00 to 2021/11/12 15:00:00's data

Uplink Interval =5s, means DDS75-LB/LS will send one packet every 5s. range 5~255s.

## 2.7 Frequency Plans

The DDS75-LB/LS uses OTAA mode and below frequency plans by default. Each frequency band use different firmware, user update the firmware to the corresponding band for their country.

<http://wiki.dragino.com/xwiki/bin/view/Main/End%20Device%20Frequency%20Band/>

## 3. Configure DDS75-LB/LS

### 3.1 Configure Methods

DDS75-LB/LS supports below configure method:

- AT Command via Bluetooth Connection (**Recommended**): [BLE Configure Instruction](#).
- AT Command via UART Connection : See [UART Connection](#).
- LoRaWAN Downlink. Instruction for different platforms: See [IoT LoRaWAN Server](#) section.

### 3.2 General Commands

These commands are to configure:

- General system settings like: uplink interval.
- LoRaWAN protocol & radio related command.

They are same for all Dragino Devices which support DLWS-005 LoRaWAN Stack. These commands can be found on the wiki:

<http://wiki.dragino.com/xwiki/bin/view/Main/End%20Device%20AT%20Commands%20and%20Downlink%20Command/>

### 3.3 Commands special design for DDS75-LB/LS

These commands only valid for DDS75-LB/LS, as below:

#### 3.3.1 Set Transmit Interval Time

Feature: Change LoRaWAN End Node Transmit Interval.

**AT Command: AT+TDC**

Command Example	Function	Response
AT+TDC=?	Show current transmit Interval	30000 OK the interval is 30000ms = 30s
AT+TDC=60000	Set Transmit Interval	OK Set transmit interval to 60000ms = 60 seconds

**Downlink Command: 0x01**

Format: Command Code (0x01) followed by 3 bytes time value.

If the downlink payload=0100003C, it means set the END Node's Transmit Interval to 0x00003C=60(S), while type code is 01.

- Example 1: Downlink Payload: 0100001E // Set Transmit Interval (TDC) = 30 seconds
- Example 2: Downlink Payload: 0100003C // Set Transmit Interval (TDC) = 60 seconds

#### 3.3.2 Set Interrupt Mode

Feature, Set Interrupt mode for GPIO\_EXTI of pin.

When AT+INTMOD=0 is set, GPIO\_EXTI is used as a digital input port.

**AT Command: AT+INTMOD**

Command Example	Function	Response
AT+INTMOD=?	Show current interrupt mode	0 OK the mode is 0 =Disable Interrupt
AT+INTMOD=2	Set Transmit Interval 0. (Disable Interrupt), 1. (Trigger by rising and falling edge) 2. (Trigger by falling edge) 3. (Trigger by rising edge)	OK

**Downlink Command: 0x06**

Format: Command Code (0x06) followed by 3 bytes.

This means that the interrupt mode of the end node is set to 0x060003=3 (rising edge trigger), and the type code is 06.

- Example 1: Downlink Payload: 06000000 // Turn off interrupt mode
- Example 2: Downlink Payload: 06000003 // Set the interrupt mode to rising edge trigger

**3.3.3 Set Delta Detect Mode(Since firmware v1.3)**

Feature, Set Delta Detect Mode.

**AT+MOD=a,b,c,d**

**a:** mod=1: default mode. mod=2: Delta Detect Mode.

**b:** Interval Between each sampling. Unit: second.

**c:** Delta Threshold: If  $|(Current\ Sample\ Distance - Last\ Sample\ Distance)| \geq Delta\ Threshold$ . Sensor will record the next d# number distance and send to IoT Server. Unit: cm.

**d:** Define how many samples should be sent after Delta Threshold trigger. (The number of samples ranges from 5 to 20.)

**Note:**

- 1) When sensor is in Delta Thredhold Trigger stage. It will not response to a new trigger.
- 2) After the Delta Threshold Trigger finish and send the uplink packet, Sensor will back to Idle mode and keep sampling and check.
- 2) When delta detect feature is in used, the power consumption will be high and device is not suitable to use battery to power, please refer how to power by external power: [Can I use an external power adapter or solar panel to power motherboard?](#)

**AT Command: AT+MOD=a,b,c,d**

Command Example	Function	Response
AT+MOD=?	Show current work mode	1,0,0,0 OK
AT+MOD=2,1,30,10	Set Delta Detect Mode	OK

**Downlink Command: 0xFB**

Format: Command Code (0xFB) followed by 6 bytes.

If the downlink payload=**FB 02 0001 001E 0A**, it means set the END Node's Interval Between each sampling to 0x0001=1(S),Delta Threshold to 0x001E=30(cm), Number of samples to 0x0A=10,while type code is FB.

- **Example** : Downlink Payload: **FB020001001E0A** // Set delta detect mode, sampling every second, more than 30cm trigger delta threshold to send 10 samples.

## 4. Battery & Power Consumption

DDS75-LB use ER26500 + SPC1520 battery pack and DDS75-LS use 3000mAh Recharable Battery with Solar Panel. See below link for detail information about the battery info and how to replace.

[Battery Info & Power Consumption Analyze](#) .

## 5. OTA Firmware update

User can change firmware DDS75-LB/LS to:

- Change Frequency band/ region.
- Update with new features.
- Fix bugs.

Firmware and changelog can be downloaded from : [Firmware download link](#)

Methods to Update Firmware:

- (Recommended way) OTA firmware update via wireless: <http://wiki.dragino.com/xwiki/bin/view/Main/Firmware%20OTA%20Update%20for%20Sensors/>
- Update through UART TTL interface: [Instruction](#).

## 6. FAQ

### 6.1 What is the frequency plan for DDS75-LB/LS?

DDS75-LB/LS use the same frequency as other Dragino products. User can see the detail from this link: [Introduction](#)

### 6.2 Can I use DDS75-LB/LS in condensation environment?

DDS75-LB/LS is not suitable to be used in condensation environment. Condensation on the DDS75-LB/LS probe will affect the reading and always got 0.

## 7. Trouble Shooting

### 7.1 Why I can't join TTN V3 in US915 / AU915 bands?

It is due to channel mapping. Please see below link: [Frequency band](#)

### 7.2 AT Command input doesn't work

In the case if user can see the console output but can't type input to the device. Please check if you already include the **ENTER** while sending out the command. Some serial tool doesn't send **ENTER** while press the send key, user need to add ENTER in their string.

### 7.3 Why does the sensor reading show 0 or "No sensor"

1. The measurement object is very close to the sensor, but in the blind spot of the sensor.
2. Sensor wiring is disconnected
3. Not using the correct decoder

### 7.4 Abnormal readings The gap between multiple readings is too large or the gap between the readings and the actual value is too large

- 1) Please check if there is something on the probe affecting its measurement (condensed water, volatile oil, etc.)
- 2) Does it change with temperature, temperature will affect its measurement
- 3) If abnormal data occurs, you can turn on DEBUG mode, Please use downlink or AT COMMAN to enter DEBUG mode.

downlink command: **F1 01**, AT command: **AT+DDEBUG=1**

- 4) After entering the debug mode, it will send 20 pieces of data at a time, and you can send its uplink to us for analysis

Its original payload will be longer than other data. Even though it is being parsed, it can be seen that it is abnormal data.

Please send the data to us for check.

## 8. Order Info

Part Number: **DDS75-LB-XX** or **DDS75-LS-XX**

**XX: The default frequency band**

- **AS923**: LoRaWAN AS923 band
- **AU915**: LoRaWAN AU915 band
- **EU433**: LoRaWAN EU433 band
- **EU868**: LoRaWAN EU868 band
- **KR920**: LoRaWAN KR920 band
- **US915**: LoRaWAN US915 band
- **IN865**: LoRaWAN IN865 band
- **CN470**: LoRaWAN CN470 band

## 9. Packing Info

**Package Includes:**

- DDS75-LB or DDS75-LS LoRaWAN Distance Detection Sensor x 1

**Dimension and weight:**

- Device Size: cm
- Device Weight: g
- Package Size / pcs : cm
- Weight / pcs : g

## 10. Support

- Support is provided Monday to Friday, from 09:00 to 18:00 GMT+8. Due to different timezones we cannot offer live support. However, your questions will be answered as soon as possible in the before-mentioned schedule.
- Provide as much information as possible regarding your enquiry (product models, accurately describe your problem and steps to replicate it etc) and send a mail to [Support@dragino.cc](mailto:Support@dragino.cc).